

Translation of the Original Operating Instructions

MAB 155



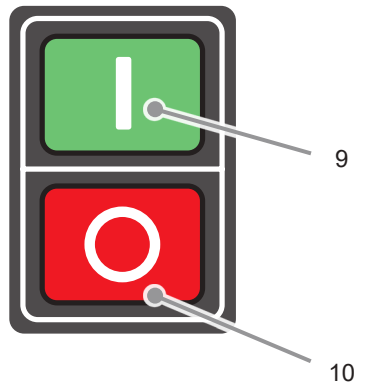
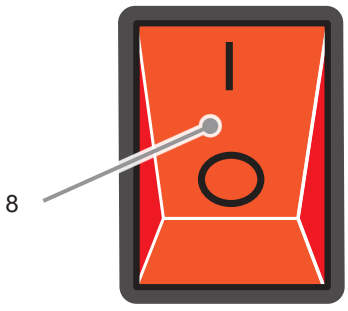

Table of contents

General instructions3
Safety5
Components / delivery contents9
Before using for the first time9
Preparation.9
Using.12
Eliminating blockages.14
Cleaning/maintenance14
Storage15
Troubleshooting16
Technical data17
EC Declaration of Conformity18

Dear Customer,
 Before using the machine, please read the operating instructions contained in these operating instructions on startup, safety, intended use as well as cleaning and care.
 The links and illustrations in these instructions refer to the illustrations on the inside of the cover.
 Keep these operating instructions for later use and pass them onto the next owner of the machine.

General instructions

Copyright

This document is subject to copyright. Duplication or reprinting, even in part as well as reproduction of the illustrations, even if modified, is only permitted with written consent of the manufacturer.

Liability disclaimer

All technical information, data and instructions contained in these operating instructions for startup, operation and care correspond to the latest requirements at the time of printing.

The manufacturer assumes no liability for damage or injury resulting from failure to observe the operating instructions, use for other than the intended purpose, unprofessional repairs, unauthorised modifications or use of non-approved spare parts and accessories, tools and lubricants.

Instructions on disposal



The packaging materials used can be recycled. When no longer required, dispose of the packing materials according to local environmental regulations.



This product may not be disposed of in the European Union via the normal household refuse. Dispose of the device via communal collection points.



The lubricant used can contain substances dangerous to the environment. Dispose of the lubricant according to local regulations. Observe the disposal instructions from the lubricant manufacturer.

Safety warning structure

The following warnings are used in these operating instructions:

DANGER

A warning of this category indicates an impending dangerous situation.

If the dangerous situation is not avoided, it may lead to serious injury or even death.

- ▶ Follow the instructions in this warning to avoid possible danger of serious injury or even death.

WARNING

A warning of this category indicates a potentially dangerous situation.

If the dangerous situation is not avoided, it may lead to serious injury or even death.

- ▶ Follow the instructions in this warning to avoid the danger of serious injury to persons.

ATTENTION

A warning of this category indicates potential danger to property.

If the situation is not avoided, it may lead to material damage.

- ▶ Follow the instructions in this warning to avoid material damage.

NOTE

- ▶ A note indicates additional information that simplifies the use of the machine.

Intended use

The machine is intended solely for drilling operations in magnetic and non-magnetic metals within the limits specified in the technical data.

Any use other than previously stated is considered as improper use.

WARNING

Danger due to improper use!

If not used for its intended purpose and/ or used in any other way, the machine may be or become a source of danger.

- ▶ Use the machine only for its intended purpose.
- ▶ Observe the procedures described in these operating instructions.

No claims of any kind will be accepted for damage resulting from use of the system for other than its intended purpose.

The risk must be borne solely by the user.

NOTE

- ▶ If used commercially, pay attention to compliance with the accident prevention and occupational safety regulations.

Safety

NOTE

When using electrical tools, the following fundamental precautions must be taken to protect against electric shock and the risk of injury and fire!

Fundamental safety instructions

- Do not use the machine in potentially flammable or explosive environments.
- Persons, who are unable to safely operate the machine due to their physical, mental or motor abilities, may only use the machine under the supervision or instruction of a person responsible.
- Persons with heart pacemakers or other medical implants must not use this machine.
- Children are not permitted to use the machine.
- Before using, check the machine and the connecting cable for damage and do not put a damaged machine into operation.
- Before beginning work, check the condition of the safety chain.
- Before beginning work, check the condition of the machine and the function of the operating elements.
- Repairs to the mains cable may only be carried out by a qualified electrician.
- Repairs to the machine may only be performed by an authorised specialist workshop or factory customer service. Unqualified repairs can lead to considerable danger for the user.
- Repairs to the machine during the guarantee period may only be performed by a customer service authorised by the manufacturer, otherwise the guarantee is invalid.
- Defective parts may only be replaced with original spare parts. Only these parts ensure that the safety requirements are met.
- Do not leave the machine unsupervised during operation.
- Store the machine in a dry, temperate location out of the reach of children.
- Do not allow the machine to stand outside and do not expose to moisture.
- Make sure that your work area is sufficiently lit (>300 Lux).
- Do not use low-power machines for heavy working.
- Pay attention to cleanliness at the workplace.
- Keep the machine clean, dry and free of oil and grease.
- Follow the instructions on lubricating and cooling the tool.

Danger from electric current!

DANGER

Danger to life from electrical current!
Contact with live wires or components can lead to serious injury or even death!

Observe the following safety precautions to avoid any danger from electric current:

- ▶ Do not open the housing of the machine. Risk of electric shock from touching live connections.
- ▶ Never immerse the machine or mains plug in water or other liquids.
- ▶ Only use extension or cable drums with a cable cross-section of at least 1.5 mm².
- ▶ Only use extension cables that are approved for the location of use.
- ▶ Check the condition of the extension cable regularly and replace if damaged.
- ▶ Avoid direct body contact with grounded parts (e.g., tubes, radiators, steel girders) to reduce the risk of electric shock in the event of a defect.
- ▶ When using the machine outside or in a humid environment, an RCD (residual circuit device) must be used.

Risk of injury!

WARNING

Improper handling of the machine increases the risk of injury!

Pay attention to the following safety instructions in order not to injure others or yourself:

- ▶ Operate the machine only with the protective equipment specified in these instructions (see section **“Personal protective equipment”**).
- ▶ **Do not** wear protective gloves when the machine is running. A glove can be caught by the drilling machine and torn off the hand. Risk of losing one or more fingers.
- ▶ Remove loose jewellery before beginning work. Wear a hair net if you have long hair.
- ▶ Always switch off the machine before changing tools, performing maintenance or cleaning. Wait until the machine has come to a complete standstill.
- ▶ Always disconnect the voltage supply before changing tools, cleaning or performing maintenance work in order to avoid unintentional starting of the machine.
- ▶ Do not put your hand into the machine while it is in operation. Remove swarf only when the machine is at a standstill. Wear protective gloves when removing swarf.

⚠ WARNING

- ▶ When working on scaffolding, the operator must be secured with a safety belt as the machine can oscillate dangerously in the event of interruption to the power supply.
- ▶ Check for secure clamping of the electromagnets on the substrate before every use (see section ***“Preparation”***).
- ▶ Secure the machine with the safety chain (D) supplied when working in an inclined or vertical position and during overhead work. The machine could fall down if the magnet is loosened or the power fails.
- ▶ Check that the tool is tightened securely before using (see section ***“Inserting the tool”***).
- ▶ Do not allow the connecting cable to hang over edges (trip effect).

Preventing damage**ATTENTION****Potential damage to property if the machine is improperly used!**

Observe the following instructions to avoid damage to property:

- ▶ Before connecting the machine, compare the connection data (voltage and frequency) on the rating plate with those of your mains power supply. The data must correspond in order to avoid damage to the machine.
- ▶ Always carry the machine by the handle.
- ▶ Do not pull the mains cable to remove the plug from the mains socket.
- ▶ Do not crush the connecting cable.
- ▶ Do not expose the connecting cables to heat or chemical liquids.
- ▶ Do not pull the connecting cable across sharp edges or hot surfaces.
- ▶ Lay the connecting cable so that it cannot be caught and wound up in the rotating parts of the machine.

Safety equipment

Restart protection



NOTE

- ▶ The machine stops automatically when the magnetic clamp is switched off or if the power supply is interrupted.

In order to prevent the machine from starting unexpectedly after switching on the magnetic clamp again or after reconnection following interruption to the power supply ("restart protection"), the machine must be switched on using the green button (9) of the motor switch.



Symbols on the machine

The symbols on the machine have the following meaning:

Symbol	Meaning
	Electric shock hazard!
	Read the operating instructions before beginning work!
	Wear protective goggles and ear protection!

Personal protective equipment

Wear the following protective equipment at all times when operating the machine:

Symbol	Meaning
	Close-fitting work protection clothing with a low tear strength
	Goggles for protecting eyes against flying parts and liquids and ear protection in areas with noise emission >80 dB(A)
	Safety shoes for protecting feet against falling objects.

Also wear the following protective equipment during special work:

Symbol	Meaning
	Helmet for protecting your head against falling objects
	Wear a harness where there is a danger of falling.
	Gloves for protection against injuries

Components / delivery contents

Machine overview

1	Core drill (not supplied as standard)
2	Tool mounting 19 mm Weldon (3/4") (concealed)
3	Gearbox
4	Ratchet handle (can be attached on both sides)
5	Engine drive
6	Operating panel (covered)
7	Magnetic foot
8	Magnet ON/OFF switch
Motor switch	
9	Green = motor on
10	Red = motor off

Scope of supply

	MAB 155 Magnetic core drilling machine
	Transport case (not illustrated)
A	ZAK075 ejector pin
B	Safety chain
	SW 4 offset screwdriver (not illustrated)

Optional accessories

Z	ZHS 400 high-performance grease spray
---	---------------------------------------

Before using for the first time

Transport inspection

As standard, the machine is supplied with the components indicated in the **Delivery contents** section.

NOTE

- ▶ Check for visible signs of damage or missing items on delivery. Report an incomplete or damaged delivery to your dealer/supplier immediately.

Preparation

This section contains important instructions on the required preparation before beginning any work.

Additional safety measures for certain work

Additional safety precautions must be taken for the following operations with the machine:

Non-horizontal work position

WARNING

Risk of injury from a falling machine.

When working in inclined or vertical position and during overhead work, the machine must be secured to prevent it from falling using the safety chain (B) supplied.

- ▶ Check the safety chain for proper function before every use. A damaged safety chain must not be used. Replace a damaged safety chain immediately.

WARNING

- ▶ Attach the safety chain in such a way that the machine moves away from the operator in the event of slipping.
- ▶ Lay the safety chain as tightly as possible around the handle of the machine.
- ▶ Check the secure fitting of the safety chain and lock before starting work.
- ▶ Use the protective equipment stipulated in the section "Personal protective equipment".

Work on scaffolding

WARNING

Risk of falling from sudden oscillating movements of the machine.

When working on scaffolding, the machine can make a sudden oscillating movement on starting or in the event of power failure.

- ▶ Secure the machine with the safety chain (B) supplied.
- ▶ Wear a safety harness to protect yourself against falling.

Check the condition of the substrate

The magnetic holding force is dependent on the condition of the substrate. The clamping force is significantly reduced by paint, zinc and scale coatings and rust.

The substrate must satisfy the following conditions in order to achieve sufficient magnetic holding force:

- The substrate must be magnetic.
- The clamping surface and the magnetic foot (7) must be clean and grease-free.
- The clamping surface must be completely smooth and level.

NOTE

- ▶ Clean the substrate and the magnetic foot (7) of the machine before use.
- ▶ Remove any unevenness and loose rust from the substrate.
- ▶ The BDS range of accessories includes special holding devices.

The best clamping effect is obtained on low-carbon steel substrate with a thickness of at least 20 mm.

Steel with low thickness

When drilling into low thickness steel, an additional steel plate (minimum dimensions 100 x 200 x 20 mm) must be placed under the workpiece. Secure the steel plate to prevent it from falling.

NF metals or workpieces with an uneven surface

A special holding device must be used when drilling into NF metals or into workpieces with an uneven surface.

Inserting the tool

The machine is equipped with a 19 Weldon (3/4") tool mount that can accommodate core drills up to a length of 30 mm.

Only use tools with the corresponding 19 mm Weldon shank.

WARNING

Risk of injury!

- ▶ Do not use damaged, soiled or worn tools.
- ▶ Change tools only when the machine is switched off and at a standstill. Disconnect the voltage supply.
- ▶ After inserting, check that the tool is engaged securely.
- ▶ Only use tools, adapter and accessories that match the machine.

Inserting the core drill

- ◆ Before mounting, clean the Weldon shank of the core drill and tool mount (2) of the machine.
- ◆ Extend the tool mount (2) with the ratchet handle (4) until both Allen screws in the tool mount (2) are freely accessible.
- ◆ Loosen both Allen screws in the tool mount (2) using the SW 4 offset screwdriver supplied.

NOTE

- ▶ Insert the appropriate ejector pin (A) before inserting a core drill.
- ◆ Insert the core drill (1) from below into the direct tool mount (2) of the machine.
- ◆ Tighten both Allen screws in the direct tool mount using the SW 4 offset screwdriver supplied

WARNING

Risk of injury from incorrectly inserted tool!

- ▶ Check for secure and correct seating of the core drill.

Removing the tool

- ◆ Extend the tool mount (2) with the ratchet handle (4) until both Allen screws in the tool mount (2) are freely accessible.
- ◆ Loosen both Allen screws in the tool mount (2) using the SW 4 offset screwdriver supplied.
- ◆ Take out the core drill (1) from below.

Using

Activating/deactivating the magnetic clamp

ATTENTION

Damage to property!

To avoid damage to the machine by overheating of the magnets:

- ▶ Only switch on the magnetic clamp when the machine is on a magnetic surface.

Activating the magnetic clamp

- ◆ Switch on the magnetic clamp with the switch (8). The indicator lamp in the switch (8) lights up.

NOTE

- ▶ The maximum magnetic holding force is only available after switching on the motor.

Deactivating the magnetic clamp

- ◆ Switch off the magnetic clamp with the switch (8). The indicator lamp in the switch (8) extinguishes.

Switching the machine ON/OFF

Switching on the machine

- ◆ Switch on the machine with the green button (9) of the motor switch.

NOTE

- ▶ The machine can only be switched on when the magnetic clamp has been switched on.
- ▶ Allow a severely overheated machine to run on at idle speed for approx. 2 minutes.
- ▶ The machine switches off automatically in the event of a power failure or if the magnetic clamp is switched off.

Switching off the machine

- ◆ Switch off the machine with the red button (10) of the motor switch.

Drilling with the machine

Drilling with core drills

When drilling with core drills, proceed as follows:

- ◆ Insert the ejector pin (A) into the core drill.
- ◆ Insert the core drill with the ejector pin as described in the section “**Inserting the tool**”.
- ◆ Place the machine at the work location, align it and switch on the magnetic clamps.
- ◆ Switch the machine on.
- ◆ Direct the core drill with the ratchet handle (4) to the material.

NOTE

Observe the following instructions when drilling with core drills:

- ▶ Drilling with core drills does not require great force. The drilling process is not accelerated by higher pressure. The drill wears faster and the machine can be overloaded.
- ▶ When working overhead, use the ZHS 400 high-performance grease spray. Spray the drill on the inside and outside before drilling. Spray the drill on the inside and outside before drilling. In the case of larger drill depths, repeat this procedure.
- ▶ Make sure that swarf is removed regularly. With larger drilling depths, break up the swarf.

Eliminating blockages

WARNING

Danger of cut injuries from broken tool parts or swarf.

- ▶ Put protective gloves on before starting work.

Blockages caused by a broken tool:

- ◆ Switch off the machine with the red button (10) of the motor switch.
- ◆ Switch off the magnetic clamp with the switch (8). The indicator lamp in the switch (8) extinguishes.
- ◆ Disconnect the voltage supply (pull out the mains plug).
- ◆ Use the ratchet handle (4) to move the machine slide to the upper position.
- ◆ Replace defective tool. Remove swarf.

Other blockages:

- ◆ Switch off the machine with the red button (10) of the motor switch. Leave the magnetic clamp switched on.
- ◆ Use the ratchet handle (4) to move the machine slide to the upper position.
- ◆ Remove swarf and check tool.

Cleaning/maintenance

WARNING

- ▶ Switch off the machine and disconnect the voltage supply before performing maintenance or cleaning (pull out the mains plug).
- ▶ When using compressed air for cleaning, wear protective goggles and gloves and protect other persons in the working area.

ATTENTION

- ▶ Never immerse the machine in water or other liquids.

Cleaning

After each use

- ◆ Remove the inserted tool.
- ◆ Remove swarf and coolant residues.
- ◆ Clean the tool and the tool holder on the machine.
- ◆ Clean the guide of the machine slide.
- ◆ Put the machine and accessories into the transport case.

Maintenance**⚠ WARNING****Danger caused by unqualified repairs!**

Unqualified repairs can lead to considerable danger for the user and cause damage to the machine.

- ▶ Repairs to electrical appliances may only be carried out by the works customer service or by specialists trained by the manufacturer.

Storage

If you do not intend to use the machine for a longer period of time, clean it as described in the section “**Cleaning**”. Store the machine and all its accessories in the transport case at a dry, clean and frost-free location.

Replacing the carbon brushes

Replacement of the carbon brushes may only be carried out by BDS or by an authorised specialist workshop. Unauthorised repairs will invalidate the guarantee.

Customer service/service

Should you have any questions on customer service/service, please contact BDS. We will be happy to give you the address of your nearest service partner.

Troubleshooting		
Error	Possible cause	Remedy
The motor does not start after pressing the ON/OFF switch or stops during operation.	Plug not inserted into socket.	Insert plug.
	Automatic circuit breaker tripped.	Switch on on automatic circuit breaker
	Magnetic clamp not switched on.	Switch on the magnetic clamp.
The automatic circuit breaker in the electrical distribution board trips.	Too many appliances connected to the same power circuit.	Reduce the number of appliances on the power circuit.
	The machine is defective.	Contact customer service.
The magnetic clamp does not function.	Magnet not switched on.	Switch on magnet.
	The surface is not magnetic.	Use a suitable base.
Tools wear excessively/are damaged.	No lubrication or not sufficiently greased.	Supply lubrication.

NOTE

- ▶ If you cannot resolve the problem with the steps described above, please contact customer service.

Technical data

Model	MAB 155	Unit
Dimensions (L x W x H)	338 x 120 x 180	mm
Magnetic foot (L x W x H)	80 x 160 x 36,5	mm
Approx. net weight.	11	kg
Operating voltage (see type plate)	230 V / 50-60 Hz or 110/125 V / 50-60 Hz	
Power consumption	1050	W
Noise emission	90	db(A)
Vibration	1.64	m/s ²
Stroke	39	mm
Core drill (short) max. Ø	12 - 35	mm
Cutting depth max.	30	mm
Gear stage 1 speed	460	rpm
Core drill assembly	Weldon 19 mm (3/4")	
Connecting cable length:	4	m
Protection class	I	
Protection type	IP20	

EC Declaration of Conformity

Name/address of the manufacturer:	BDS Maschinen GmbH Martinstraße 108 D-41063 Mönchengladbach
We hereby declare that the product	
Model:	Magnetic core drilling machine
Model	MAB 155
conforms to the following relevant regulations: <ul style="list-style-type: none"> ■ EC Directive 2006/42/EC on machinery 	
The following harmonised standards were applied in whole or in part: <ul style="list-style-type: none"> ● DIN EN ISO 12100:2011-03 ● DIN EN 62841-1:2016-07 	
Responsible person for documentation according to EC Directive 2006/42/EC - Annex II Pt.A.2. was:	
<hr style="width: 60%; margin: auto;"/> (Surname, forename, position in company of the manufacturer)	
Mönchengladbach, 1st. November, 2016	 <hr style="width: 80%; margin: auto;"/> Wolfgang Schröder, Technical Director (Legally binding signature of the issuer)

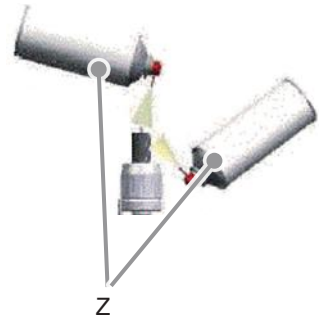
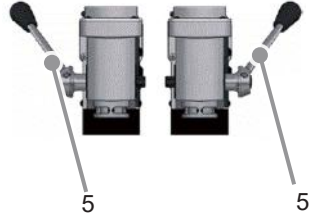

BDS Maschinen GmbH

Martinstraße 108
D-41063 Mönchengladbach

Fon: +49 (0) 2161 / 3546-0
Fax: +49 (0) 2161 / 3546-90

Internet: www.bds-maschinen.de
E-mail: info@bds-maschinen.de
